

BOGENVENTILE ARC VALVES

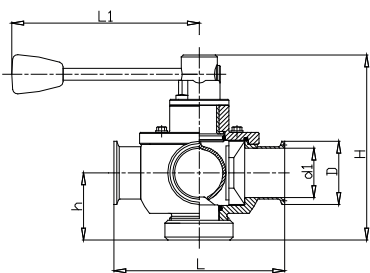
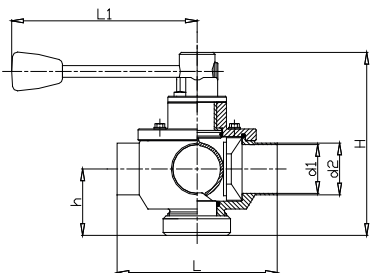

Zoll / Inch

3-Wege Bogenventil Serie 21, manuell, Schweißende 3-way arc valve series 21, manual, welded ends

DN	Typ Type	Ø d1	Ø d2	H	h	L	L1
1"	25C53M21	22,2	25,4	145	50	110	160
1½"	38C53M21	34,9	38,1	180	65	140	160
2"	51C53M21	47,5	50,8	190	70	164	190
2½"	63C53M21	60,2	63,5	200	75	210	190
3"	76C53M21	72,9	76,2	215	80	220	190
4"	102C53M21	97,4	101,6	265	110	310	270
6"	152C53M	146,8	152,4	345	140	500	270

3-Wege Bogenventil Serie 21, manuell, TC-Clamp 3-way arc valve series 21, manual, TC-clamp

DN	Typ Type	Ø d1	Ø D	H	h	L	L1
1"	25C530M21	22,2	50,5	145	50	135	160
1½"	38C530M21	34,9	50,5	180	65	165	160
2"	51C530M21	47,5	64	190	70	189	190
2½"	63C530M21	60,2	77,5	200	75	235	190
3"	76C530M21	72,9	91	215	80	245	190
4"	102C530M21	97,4	119	265	110	335	270

BOGENVENTILE ARC VALVES

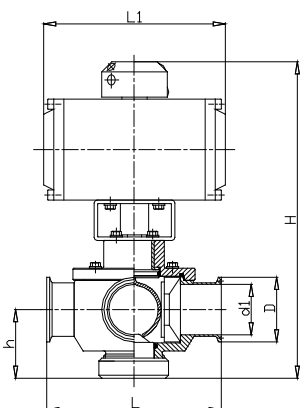
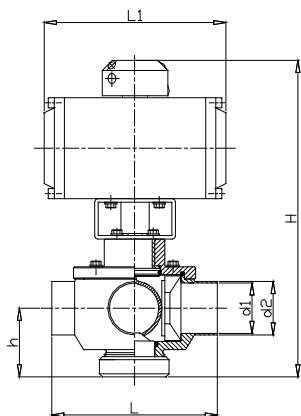
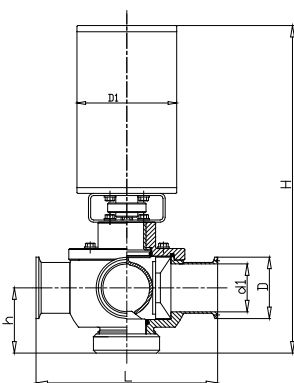
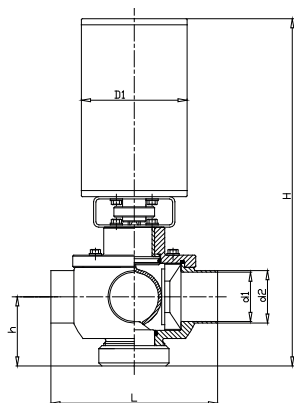

Zoll / Inch

3-Wege Bogenventil Serie 21, pneumatisch (L/L - L/F), Schweißende 3-way arc valve series 21, pneumatic (air/air - air/spring), welded ends

DN	Typ Type	Ø d1	Ø d2	H	h	L	Ø D1
1"	25C53A21	22,2	25,4	300	50	110	89
1½"	38C53A21	34,9	38,1	335	65	140	89
2"	51C53A21	47,5	50,8	340	70	164	104
2½"	63C53A21	60,2	63,5	355	75	210	104
3"	76C53A21	72,9	76,2	422	80	220	129
4"	102C53A21	97,4	101,6	474	110	310	129

3-Wege Bogenventil Serie 21, pneumatisch (L/L - L/F), TC-Clamp 3-way arc valve series 21, pneumatic (air/air - air/spring), TC-clamp

DN	Typ Type	Ø d1	Ø D	H	h	L	Ø D1
1"	25C530A21	22,2	50,5	300	50	135	89
1½"	38C530A21	34,9	50,5	335	65	165	89
2"	51C530A21	47,5	64	340	70	189	104
2½"	63C530A21	60,2	77,5	355	75	235	104
3"	76C530A21	72,9	91	422	80	245	129
4"	102C530A21	97,4	119	474	110	335	129

3-Wege Bogenventil Serie 21, pneumatisch (L/L - L/F), Schweißende 3-way arc valve series 21, pneumatic (air/air - air/spring), welded ends

DN	Typ Type	Ø d1	Ø d2	H	h	L	L1
1"	25C53Ab21	22,2	25,4	287	50	110	161
1½"	38C53Ab21	34,9	38,1	320	65	140	161
2"	51C53Ab21	47,5	50,8	328	70	164	161
2½"	63C53Ab21	60,2	63,5	342	75	210	161
3"	76C53Ab21	72,9	76,2	370	80	220	209
4"	102C53Ab21	97,4	101,6	423	110	310	209
6"	152C53Ab	146,8	152,4	540	140	500	333

Pneumatiktrieb mit Aluminiumgehäuse – Serie B, Gehäuse mit PTFE Beschichtung auf Anfrage
Pneumatic actuator with aluminium housing – series B, PTFE coated housing upon request

3-Wege Bogenventil Serie 21, pneumatisch (L/L - L/F), TC-Clamp 3-way arc valve series 21, pneumatic (air/air - air/spring), TC-clamp

DN	Typ Type	Ø d1	Ø D	H	h	L	L1
1"	25C530Ab21	22,2	50,5	287	50	135	161
1½"	38C530Ab21	34,9	50,5	320	65	165	161
2"	51C530Ab21	47,5	64	328	70	189	161
2½"	63C530Ab21	60,2	77,5	342	75	235	161
3"	76C530Ab21	72,9	91	370	80	245	209
4"	102C530Ab21	97,4	119	423	110	335	209

Pneumatiktrieb mit Aluminiumgehäuse – Serie B, Gehäuse mit PTFE Beschichtung auf Anfrage
Pneumatic actuator with aluminium housing – series B, PTFE coated housing upon request