

BOGENVENTILE ARC VALVES

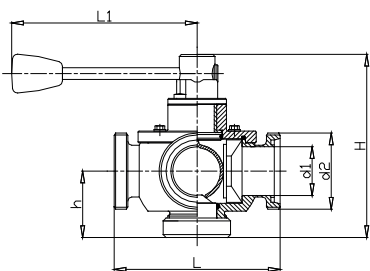
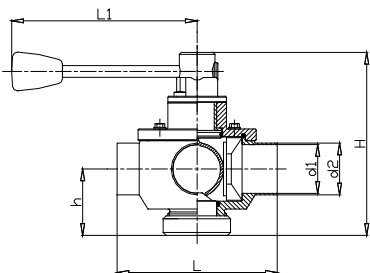

DIN

3-Wege Bogenventil Serie 21, manuell, Schweißende DIN 11850 3-way arc valve series 21, manual, welded ends DIN 11850

DN	Typ Type	Ø d1	Ø d2	H	h	L	L1
25	25D53M21	26	29	145	50	128	160
40	40D53M21	38	41	180	65	160	160
50	50D53M21	50	53	190	70	164	190
65	65D53M21	66	70	215	80	220	190
80	80D53M21	81	85	230	90	230	190
100	100D53M21	100	104	265	110	260	270
150	150D53M	150	154	345	140	500	270

3-Wege Bogenventil Serie 21, manuell, Gewinde DIN 11851 3-way arc valve series 21, manual, male ends DIN 11851

DN	Typ Type	Ø d1	Ø d2	H	h	L	L1
25	25D530M21	26	52	145	50	136	160
40	40D530M21	38	65	180	65	164	160
50	50D530M21	50	78	190	70	187	190
65	65D530M21	66	95	215	80	233	190
80	80D530M21	81	110	230	90	263	190
100	100D530M21	100	130	265	110	311	270

BOGENVENTILE ARC VALVES

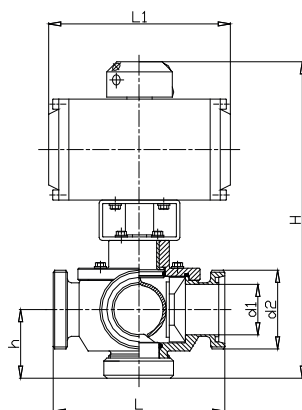
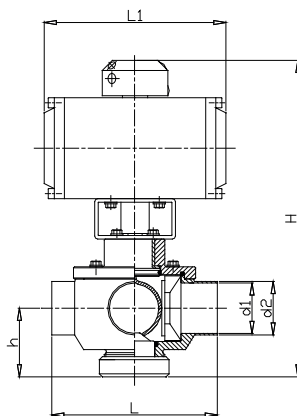
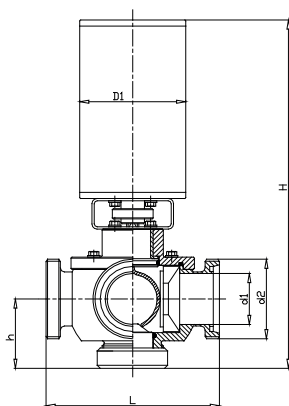
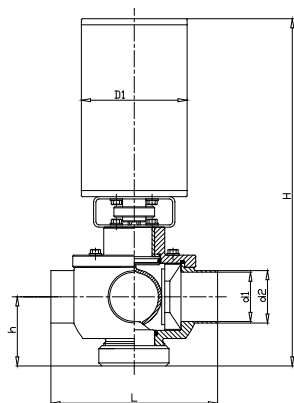

DIN

3-Wege Bogenventil Serie 21, pneumatisch (L/L - L/F), Schweißende DIN 11850 3-way arc valve series 21, pneumatic (air/air - air/spring), welded ends DIN 11850

DN	Typ Type	Ø d1	Ø d2	H	h	L	Ø D1
25	25D53A21	26	29	300	50	128	89
40	40D53A21	38	41	335	65	160	89
50	50D53A21	50	53	340	70	164	104
65	65D53A21	66	70	422	80	220	129
80	80D53A21	81	85	440	90	230	129
100	100D53A21	100	104	474	110	260	129

3-Wege Bogenventil Serie 21, pneumatisch (L/L - L/F), Gewinde DIN 11851 3-way arc valve series 21, pneumatic (air/air - air/spring), male ends DIN 11851

DN	Typ Type	Ø d1	Ø d2	H	h	L	Ø D1
25	25D530A21	26	52	300	50	136	89
40	40D530A21	38	65	335	65	164	89
50	50D530A21	50	78	340	70	187	104
65	65D530A21	66	95	422	80	233	129
80	80D530A21	81	110	440	90	263	129
100	100D530A21	100	130	474	110	311	129

3-Wege Bogenventil Serie 21, pneumatisch (L/L - L/F), Schweißende DIN 11850 3-way arc valve series 21, pneumatic (air/air - air/spring), welded ends DIN 11850

DN	Typ Type	Ø d1	Ø d2	H	h	L	L1
25	25D53Ab21	26	29	287	50	128	161
40	40D53Ab21	38	41	320	65	160	161
50	50D53Ab21	50	53	328	70	164	161
65	65D53Ab21	66	70	370	80	220	209
80	80D53Ab21	81	85	386	90	230	209
100	100D53Ab21	100	104	423	110	260	209
150	150D53Ab	150	154	540	140	500	333

Pneumatiktrieb mit Aluminiumgehäuse – Serie B, Gehäuse mit PTFE Beschichtung auf Anfrage
Pneumatic actuator with aluminium housing – series B, PTFE coated housing upon request

3-Wege Bogenventil Serie 21, pneumatisch (L/L - L/F), Gewinde DIN 11851 3-way arc valve series 21, pneumatic (air/air - air/spring), male ends DIN 11851

DN	Typ Type	Ø d1	Ø d2	H	h	L	L1
25	25D530Ab21	26	52	287	50	136	161
40	40D530Ab21	38	65	320	65	164	161
50	50D530Ab21	50	78	328	70	187	161
65	65D530Ab21	66	95	370	80	233	209
80	80D530Ab21	81	110	386	90	263	209
100	100D530Ab21	100	130	423	110	311	209

Pneumatiktrieb mit Aluminiumgehäuse – Serie B, Gehäuse mit PTFE Beschichtung auf Anfrage
Pneumatic actuator with aluminium housing – series B, PTFE coated housing upon request